

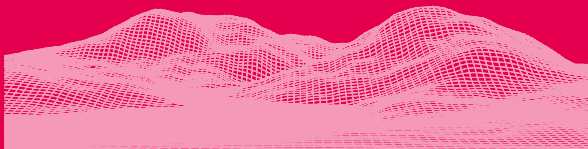

SONIC
MEGA
8K S



Dear User,

Thank you for joining us. Please read the Sonic Mega 8K S manual thoroughly and follow the instructions step by step to get the best printing experience.

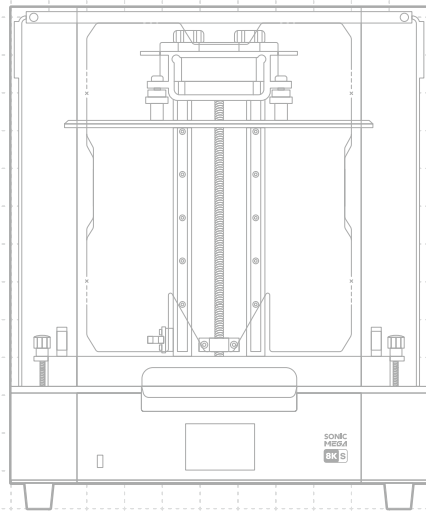

01 Introduction

Printer Parts

PART.1
Building Plate

PART.2
Resin Vat

PART.3
LCD Screen

PART.4
Front USB Port

PART.5
Touch Panel

PART.6
Lift-Up Lid

PART.7
Drip Hanger

PART.8
Z-axis

PART.9
Dual Fan

PART.10
Pump & Fill Port

PART.11
Power Switch
Power Socket

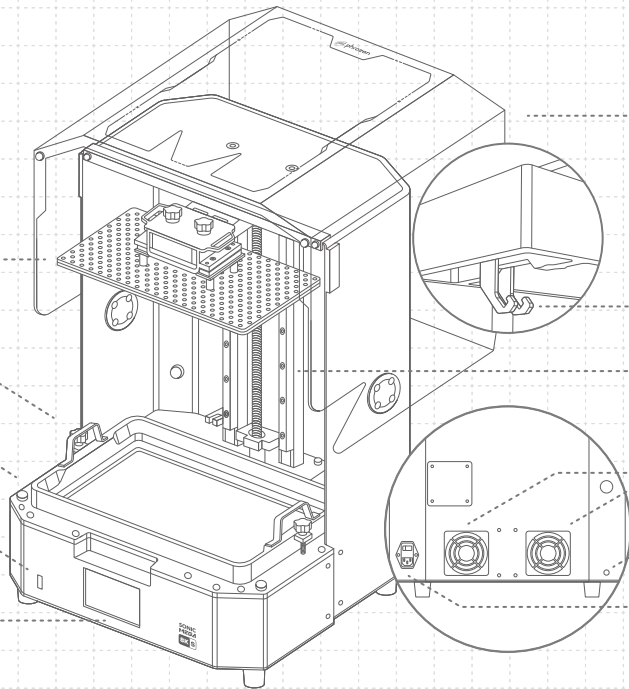

The Toolbox



Warranty Card



PIXUP Card



Chitubox Pro
Gift Card



Gloves



AC Cable 1.5m
Standard (EU/US)



Plastic Funnel



Metal Scraper



Plastic Scraper



Allen Wrenches Set



USB Stick



Magnetic Fan Cover



Vat Screws

Operation

System	Phrozen OS
Operation	3.5 inch Touch Panel
Slicer Software	CHITUBOX V1.9.6 and above (Or others)
Connectivity	USB

Printing Specifications

Technology	Resin 3D Printer - LCD Type
Light Source	405nm ParaLED® Matrix 3.0
XY Resolution	43 μm
Layer Thickness	0.01 - 0.30 mm
Max Printing Speed	600 layers / hr
Compatible File Format	.CTB / .PRZ
Power Requirement	AC100-240V ; 50-60Hz

Hardware Specifications

Printer Size	47.2 x 38 x 56.6 cm
Printing Volume	33 x 18.5 x 30 cm
Printer Weight	26 kg

* All specifications have been tested in a laboratory. Certain specifications are subject to change without prior notice. For the latest update, please refer to Phrozen's official website.

02 Key Notes Before Start

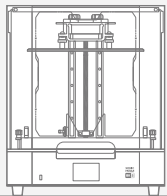

Stable Printing Environment

Store your 3D printer in a dry and well-ventilated environment. Place it on a flat surface and avoid direct sunlight exposure.

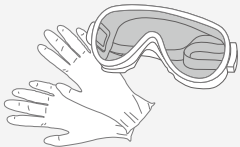

Protective Measures

While printing and using resin, please make sure to wear gloves, masks, protective goggles, and long-sleeved clothing.

Maintenance

Clean the Z-Axis

First, wipe the z-axis T-screw with cleanroom wipers. Then, apply a thin layer of general lubricant so that it whirls smoothly.

Clean the 3D Printer

Use sanitizing alcohol and tissue paper to carefully clean the printer, the resin vat, and the building plate.

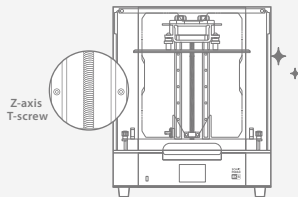

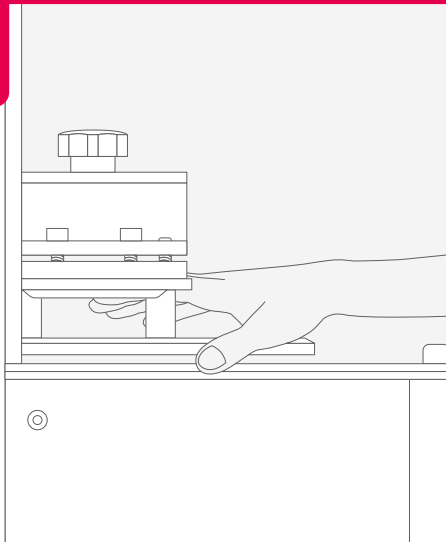

Z-Axis Calibration

The Sonic Mega 8K S comes with a pre-calibrated building plate, so you can start printing straight out of the box.

If you need to change the release film or install accessories, please re-calibrate your z-axis afterward.

If you have any technical questions, please scan the QR codes to contact our support team.



03 Prepare Your 3D Printer

For first-time use, please thoroughly follow the steps below to conduct the LCD Test to make sure that your 3D printer is ready to print.

LCD Test

- 1 Click on [TOOLS]. Then click on [LCD TEST].
- 2 Check to see if the LCD screen displays the same image as seen on the touch panel.
- 3 When the LCD screen clearly displays all the images, the LCD TEST is complete.

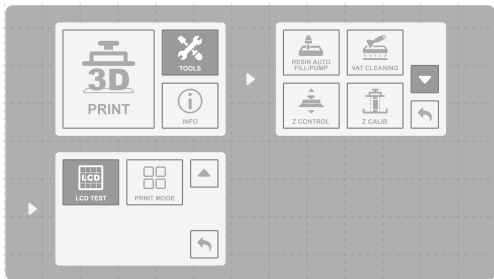

* Please refer to the actual operation situation based on the printer display.

04 Printing Your First Print

File Format

The Sonic Mega 8K S is compatible with .PRZ and .CTB formats. Use the slicer software of your choice to convert your .STL or .OBJ files into .PRZ or .CTB files.

Prepare Your 3D File

- 1 On your computer, import the .STL or .OBJ file to the slicer software of your choice.
- 2 Click [SETTINGS] to add a new printer and choose [Sonic Mega 8K S]. Then, set your print parameters according to the resin you will use.
- 3 Slice the 3D file and save it as a .CTB/.PRZ file before transferring it to a USB stick.

Test Files for your first Print

- 1 The USB included in the toolbox contains both .STL and .CTB files of two test models: "Phrozen test "and "Phrozen_XP Finder".
- 2 You can directly print the .CTB files on the USB with Aqua-Gray 8K/TR300 Resin.
- 3 If you are printing with other resins, slice the .STL files with the compatible parameter settings required for your resin.



Download Slicer



Resin Profile



Phrozen_XP_Finder

* Please refer to the resin profile for the updated printing parameters and use the XP_finder file on the USB to find the optimal printing parameter.

Performing Your First Print

This printing test is to be performed with Aqua-Gray 8K and Phrozen XP Finder test file.

- 1 Tighten the screws on your resin vat and building plate. Make sure that both of them are clean from debris.
- 2 Shake the resin bottle for 1 minute. When pouring, make sure the resin does not exceed the mark on the resin vat.
- 3 Plug your USB into the printer and choose print. Choose the Phrozen_XP_Finder_Mega8KS_AQ8K.ctb and start printing.
- 4 While printing, please keep the lid closed to prevent light exposure that may affect your prints.
- 5 Once printing is complete, carefully remove the building plate and use a metal scraper to carefully remove your print.
- 6 Use a 95% sanitizing alcohol or Phrozen Wash Resin Cleaner to clean your printed models. After it's fully dry, post-cure your models with a curing station.

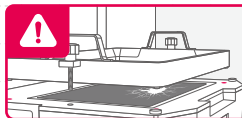

NOTICE: When installing the resin vat, please align the screws at the bottom of the resin vat with the platform grooves to avoid damage caused by the screws scratching the LCD panel.

After-Sales Service & Warranty

- Phrozen offers a one-year warranty for all parts, excluding consumable components such as the LCD screen and ACF film.
- Sonic Mega 8K S LCD screen is covered under a 3-month warranty. Please note that this warranty does not cover any damages caused by human factors.
- If you encounter any difficulties, please scan the QR codes down below to contact us.

Contact us!



Congratulations!

You have just completed your first run.
We hope you've had a great experience!

Please follow Phrozen's social media accounts
and subscribe to our YouTube channel to learn
more about printing tips and share information
with the community.



Facebook



Facebook Group
Sonic Mega 8K



YouTube



Instagram